









- 

Integrierte Absturz- und Auflaufsicherung
Integrated derailment and bumping protection
Avec anti- chute et anti- basculement
- 

Laufrollenprofil passend für alle Normträger
Adjustable to all standard beam sizes
Adaptable sur tous profils de roulement standard
- 

Kugelgelagerte Laufrollen
Trolley wheels with ball bearing
Galets avec roulement à billes
- 

Einhängeöse
Load suspension eye
Oeillet de suspension
- 

Verzinkte Lastbolzen, Einstellscheiben und Befestigungsmuttern
Zinc plated load bars, washers and locking nuts
Traverses, entretoises et bagues zinguées
- 

Deutsche Herstellung
Manufactured in Germany
Fabrication Européenne

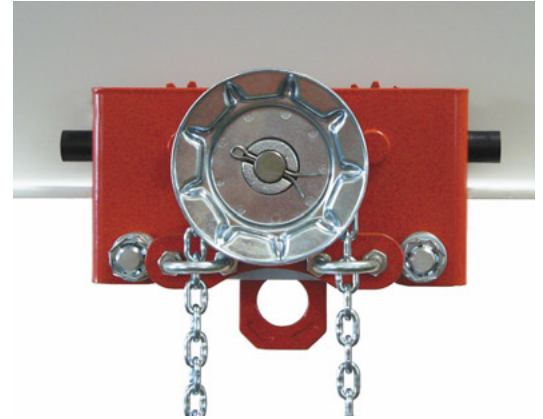

Auch als Roll-, Elektro- oder Druckluftfahrwerk lieferbar
Also available as push travel, electric- or pneumatic trolley
Aussi disponible comme chariot à pousser, électrique ou pneumatique

Tragfähigkeit	Flanschbreite von - bis bei Lastbolzengröße		Fahrweg bei Abhaspelung von 30 m Handkette	Handkraft	Kurvenradius min. min. curve radius Radius de courbe min.		Gewicht ohne Handkette	
	Capacity				Hand chain pull	Standard Fahrwerk	modifiziertes Fahrwerk	Weight without hand chain
Capacité	Largeur de fer de - à pour traverse		Translation par déroulement de 30 m de chaîne de manoeuvre	Effort à la chaîne de manoeuvre		standard trolley	modified trolley	Poids sans chaîne de manoeuvre
kg	1N mm	2N mm			m	daN	m	m ^{(1) (2)}
500	50 - 146	147 - 302	9,9	4	3,0	1	9,2	11,0
1000	50 - 179	180 - 310	14,1	8	3,0	1	17,3	18,3
2000	66 - 185	186 - 310	14,1	12	3,5	1,5	33,5	36,1
3200	74 - 196	197 - 310	9,0	8	6,5	1,8	63,9	68,1
4000	74 - 196	197 - 310	9,0	10	6,5	1,8	63,9	68,1
5000	74 - 192	193 - 310	9,0	13	7,0	2	76,3	79,5
6300	119 - 215	216 - 312	6,3	10	8,0	2,2	164,8	169,6
7500	119 - 215	216 - 312	6,3	12	8,0	2,2	164,8	169,6
10000	119 - 215	216 - 312	6,3	15	8,0	2,2	164,8	169,6
12000	119 - 215	216 - 312	6,3	18	8,0	2,2	164,8	169,6
15000	160 - 310	-	6,6	20	-	4,5	525	-
20000	160 - 310	-	6,6	20	-	4,5	525	-
25000	160 - 310	-	6,6	21	-	-	594	-

(1) Optional gegen Mehrpreis./ As option for add. price./ Option pour prix additionnel.

(2) noch kleinere Kurvenradien auf Anfrage./ Smaller curve radius on request./ Radius de courbe plus petit sur demande.



20/94 AFH

Einschienen- Haspelfahrwerk/ Monorail- Hand Geared Trolley/ Chariot à avance par chaîne

HADEF®



ISO 9001
certified company

PREMIUM LINE

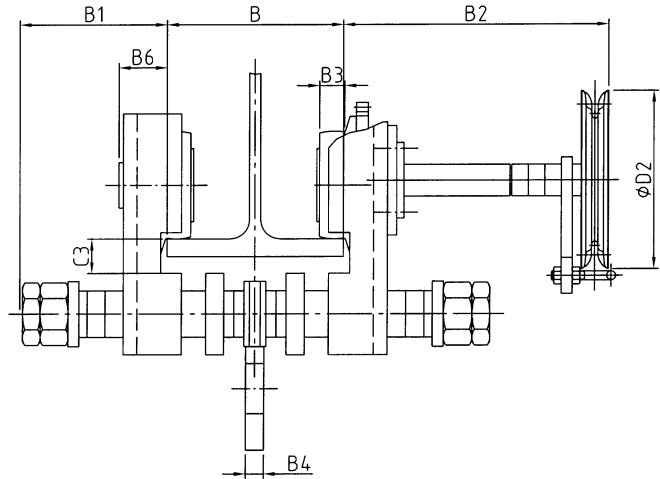
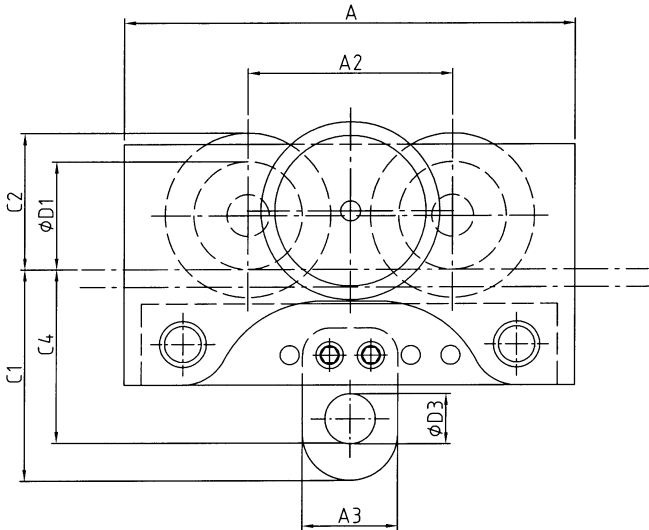

Tragfähigkeit Capacity Capacité	Hauptabmessungen in mm Main dimensions in mm Dimensions principales en mm																				
	B Flanschbreite von - bis bei Lastbolzengröße Flange width from - to for load bar size Lageur de fer de - à pour traverse						B1 bei Lastbolzengröße at load bar size pour traverse												ϕ	ϕ	ϕ
	1N	2N	A	A2	A3	1N	2N	B2	B3	B4	B6	C1	C2	C3	C4	D1	D2	D3			
	kg																				
500	50 - 146	147 - 302	234	93	70	97	126	112	20	11	24	128	92	20	108	50	135	40			
1000	50 - 179	180 - 310	287	142	70	72	95	236	20	11	31	197	90	24	112	65	135	40			
2000	66 - 185	186 - 310	350	172	95	133	135	260	23	15	40	198	107	30	165	85	135	55			
3200	74 - 196	197 - 310	428	209	104	145	145	281	28	20	46	202	150	31	170	120	135	55			
4000	74 - 196	197 - 310	428	209	104	145	145	281	28	20	46	202	150	31	170	120	135	55			
5000	74 - 192	193 - 310	492	223	120	153	164	283	28	20	53	256	150	31	206	120	195	73			
6300	119 - 215	216 - 312	650	253	120	183	183	248	33	35	62	279	185	42	234	150	270	80			
7500	119 - 215	216 - 312	650	253	120	183	183	248	33	35	62	279	185	42	234	150	270	80			
10000	119 - 215	216 - 312	650	253	120	183	183	248	33	35	62	279	185	42	234	150	270	80			
12000	119 - 215	216 - 312	650	253	120	183	183	248	33	35	62	279	185	42	234	200	270	80			
15000	160 - 310	-	975	380	376	210	225	288	55	60	103	402	272	43	348	250	365	100			
20000	160 - 310	-	975	380	376	210	-	288	55	60	103	402	272	43	348	250	365	100			
25000	160 - 310	-	1100	432	-	210	-	178	60	-	102	-	341	46	-	300	440	-			





Optionen/ Options / Options

Drehschemelfahrwerk für sehr
kleine Kurvenradien
Swivelling trolley for very small
curve radius
Boogie pour radius de courbe
plus petite

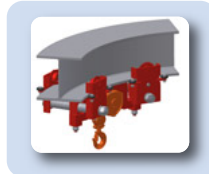

Feststellvorrichtung
Beam locking device
Dispositif de blocage sur fer

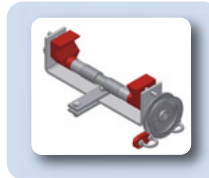

größere Flanschbreiten möglich
larger flange width available
largeur de fer plus grande possible



Gummipuffer
Rubber end stops
Butées caoutchouc

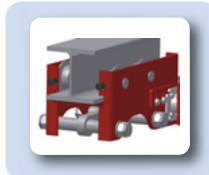

Zahnstangenantrieb
Rack and pinion drive
Entraînement sur crémaillère

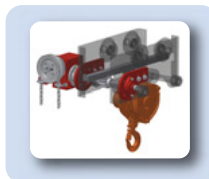

Komplett verzinkte Ausführung
Totally zinc plated trolley
Réalisation entièrement zinguée



ATEX

