

$P = 250 \text{ kg}$   
 $(Gk = 40 \text{ kg})$

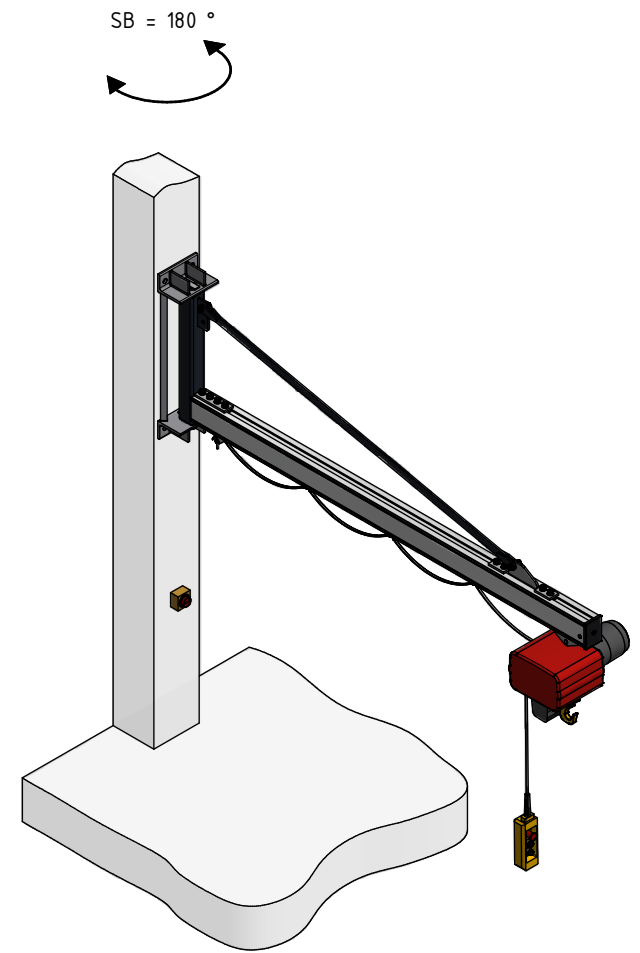

Dies ist eine allgemeine Skizze! Technische Änderungen vorbehalten!

Wandschwenkran Typ UNILIFT UW (UW2,5-2,9)

140

05.02.2020