

# Transportmaße

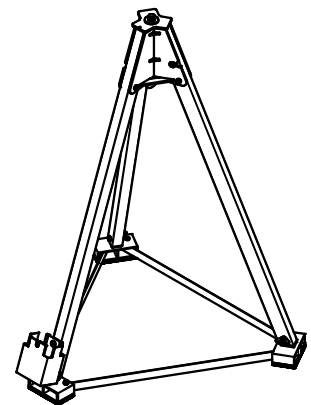
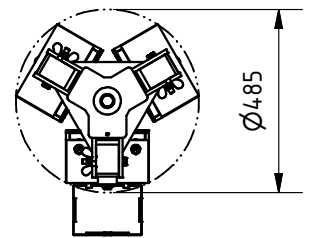
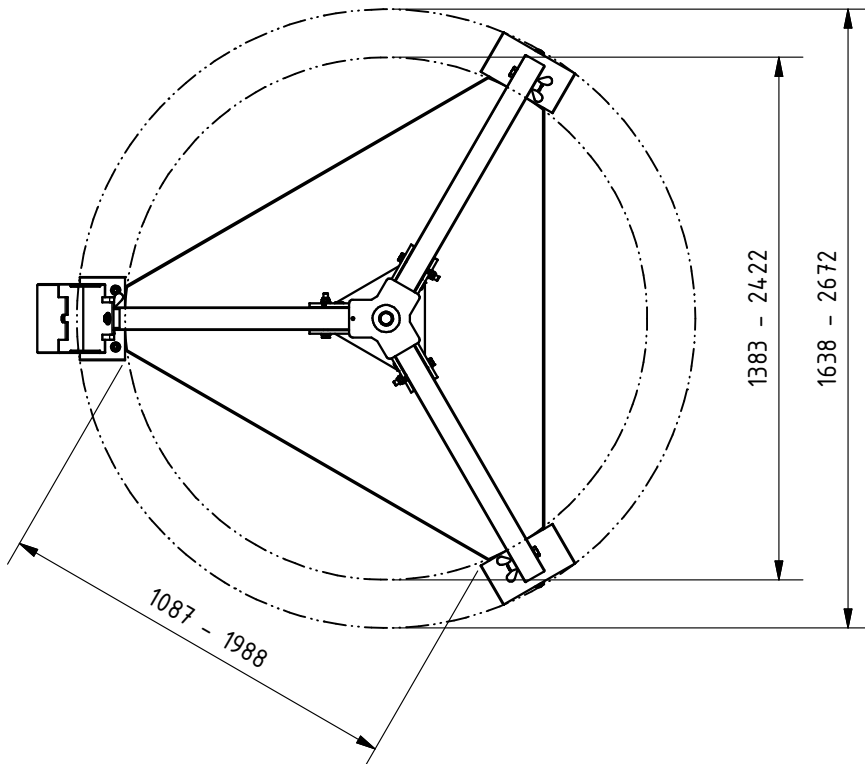
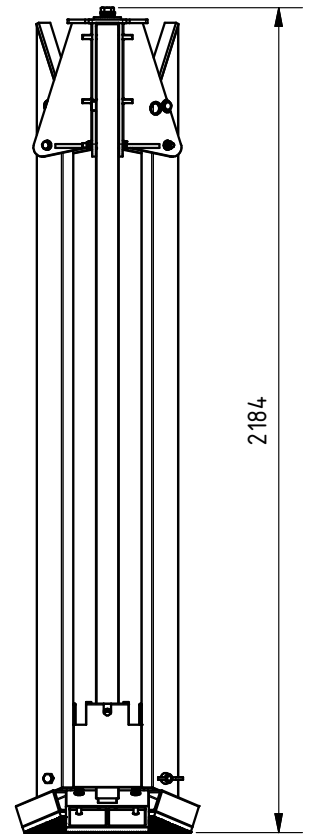
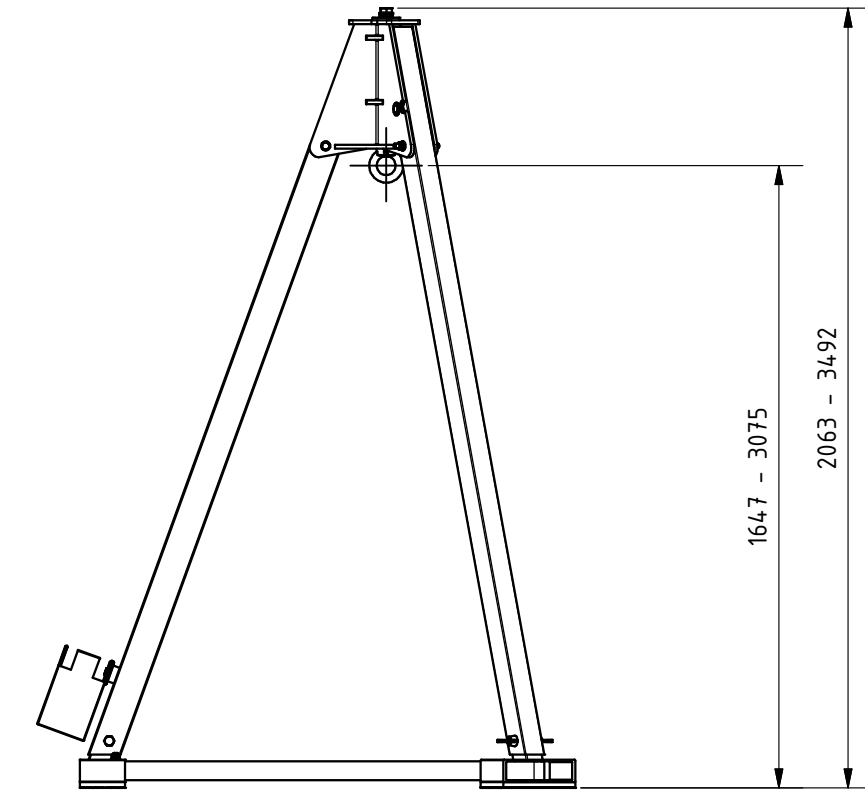

And. 6	Anderungsdatum 05.03.2026	Anderung durch Danny Büdinger		Allgemeintoleranz ISO 2768 - mK	Artikelnummer 1622000	Format A4	
 <a href="http://www.schilling-fn.de">www.schilling-fn.de</a> ■ SCHILLING Kran- und Hebeteknik GmbH ■ Ernst-Zimmermann-Straße 9-11 ■ 88045 Friedrichshafen ■ Deutschland			Zeichnungsnummer 1622000-000		Masse 58,54 kg	Maßstab 1 : 20	
			Titel, zusätzlicher Titel  Dreibock		Werkstoff		
					Erstellungsdatum 02.03.2022	Erstellt durch Bettina Neuwirth	Blatt 1/3